

管理棟 南立面図

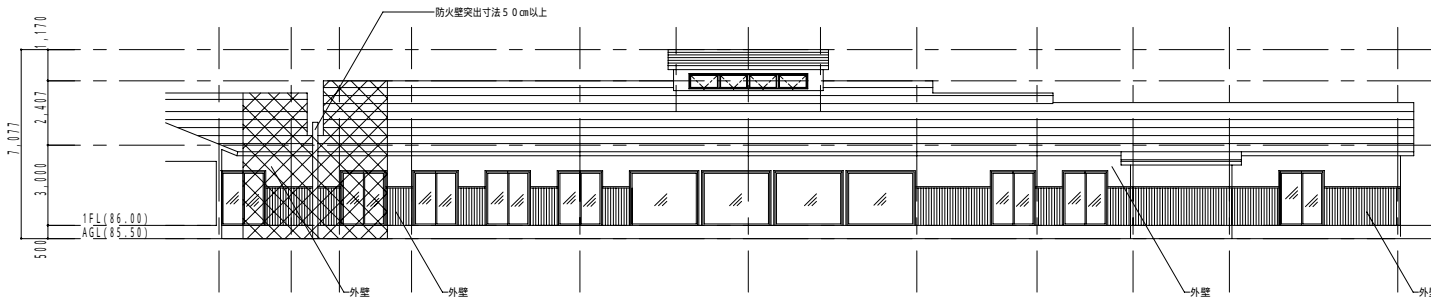

管理棟 北立面図

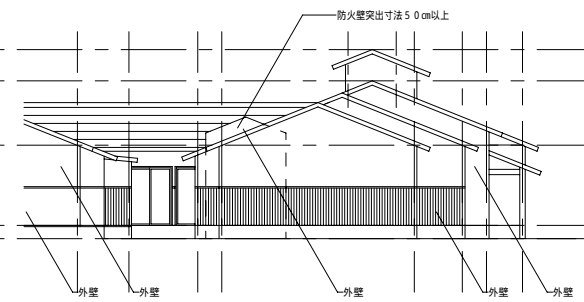

管理棟 西立面図

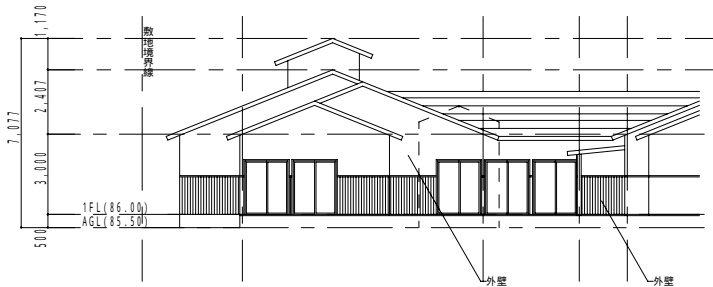

管理棟 東立面図

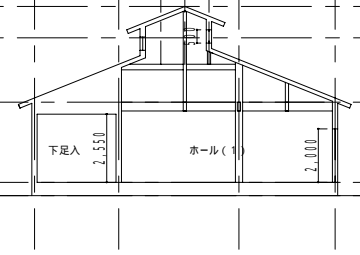

管理棟 断面図

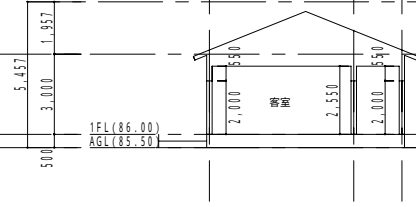

管理棟 断面図

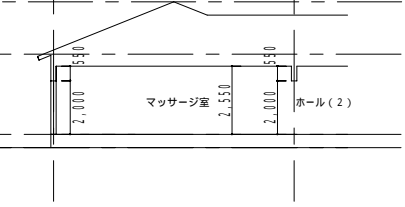

管理棟 断面図

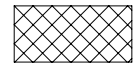

は、準耐火構造の範囲を示す

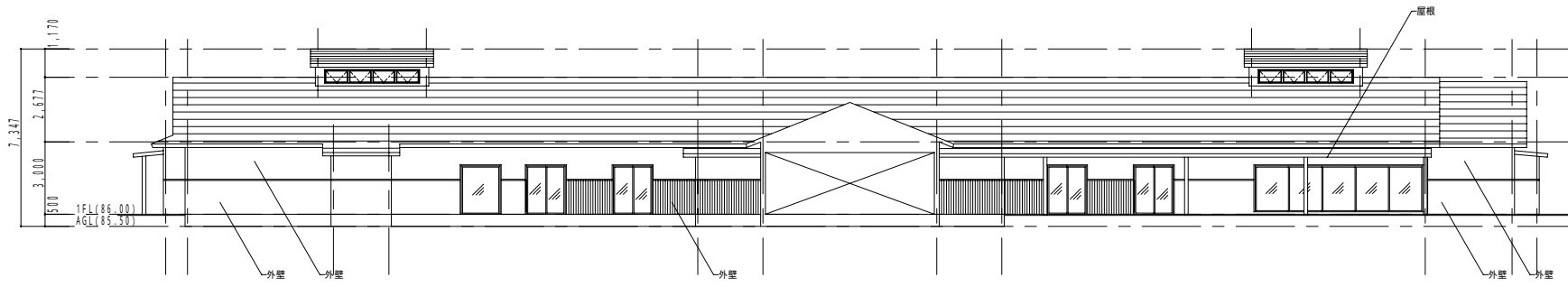

温浴棟 南立面图

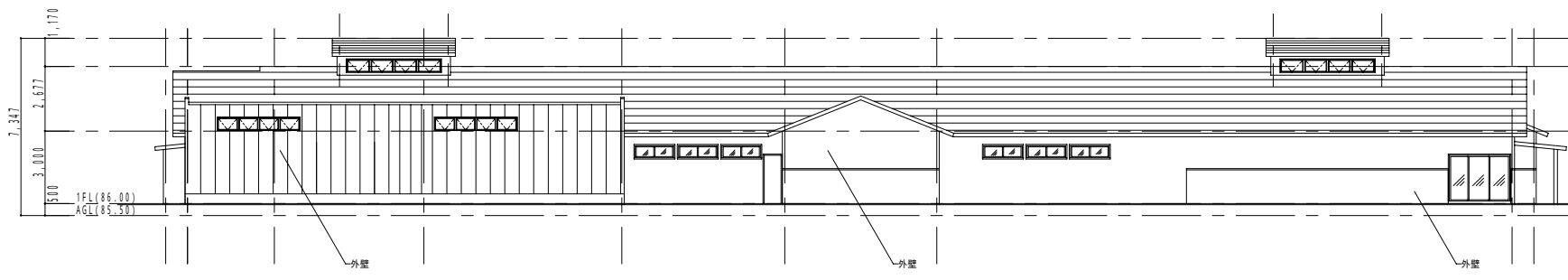

温浴棟 北立面图

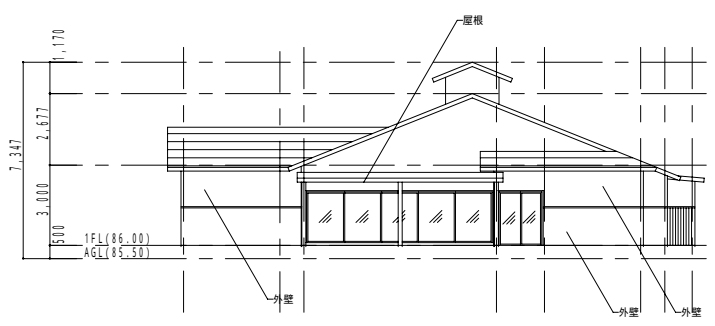

温浴棟 西立面图

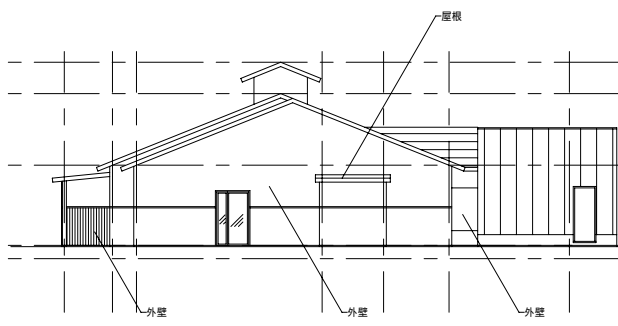

温浴棟 東立面图

